

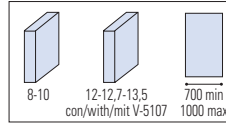

## EVOLUTION

### V-5100



### V-5150

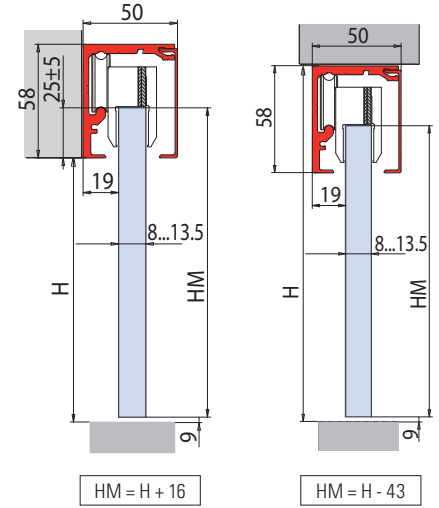
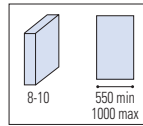

### V-5100 | V-5150 SET 1

- Set per 1 ante scorrevole, fissaggio a parete/soffitto
- Sliding door set, wall/ceiling installation
- Schiebetürset für 1 fig, Wand-Deckenmontage

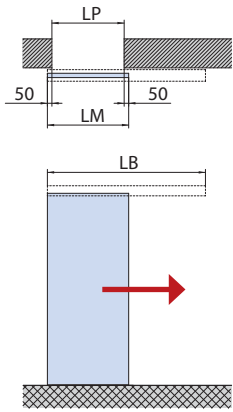

$$LB = LP \times 2 + 150$$

$$LM = LP + 100$$

### V-5100 | V-5150 SET 2

- Set per 2 ante scorrevoli, fissaggio a parete/soffitto
- Sliding doors set, wall/ceiling installation
- Schiebetürset für 2 fig, Wand-Deckenmontage

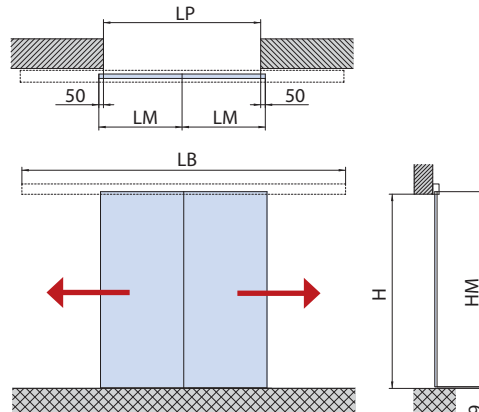

$$LB = LP \times 2 + 100$$

$$LM = (LP + 100) / 2$$

### LAVORAZIONE VETRO GLASS PREPARATION GLASBEARBEITUNG

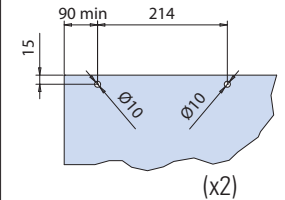

- Fori optional per V-5102
- Holes optional for V-5102
- Bohrungen Optional für V-5102

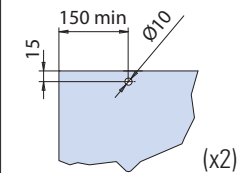

- Foro optional per V-5152
- Hole optional for V-5152
- Bohrung Optional für V-5152

xla209 / xla281c

## COMPONENTI | COMPONENTS | EINZELTEILE



V-5100



V-5102 120 Kg



V-5152 60 Kg



V-012

V-5101

Cod.	Fin.   Fin. Oberf.	V-5100 SET 1 FIX	V-5100 SET 1-MIS	V-5100 SET 2 FIX	V-5100 SET 2-MIS	V-5150 SET 1 FIX	V-5150 SET 1-MIS	V-5150 SET 2 FIX	V-5150 SET 2-MIS
V-5100 L=2000 L=2500 L=3000 L=4000 L=6000	AN / IXE	1	-	1	-	1	-	1	-
V-5100-MIS L=1500 → 6000	AN / IXE	-	1	-	1	-	1	-	1
V-5102	-	1	1	2	2	-	-	-	-
V-5152	-	-	-	-	-	1	1	2	2
V-5101	AN / IXE	1	1	1	1	1	1	1	1
V-012	AN / NS	1	1	2	2	1	1	2	2



## EVOLUTION

### V-5103

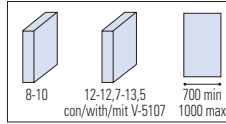

### V-5153

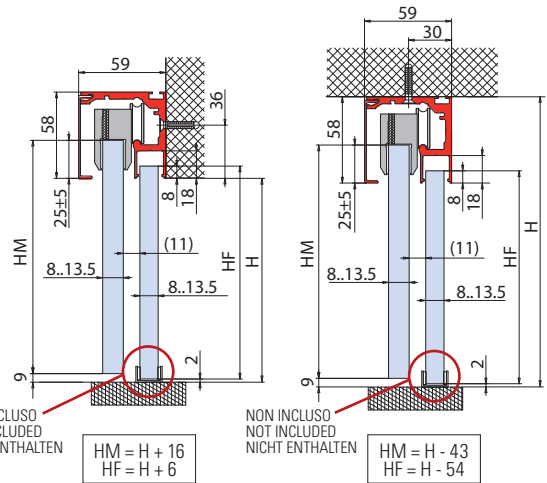
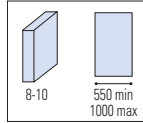

### V-5103 | V-5153 SET 1

- Set per 1 anta scorrevole e vetro fisso, fissaggio a parete/soffitto
- Sliding door set with fixed panel, wall/ceiling installation
- Schiebetürset für 1 flg mit Seitenteil, Wand-Deckenmontage

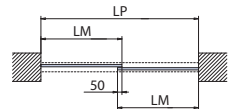
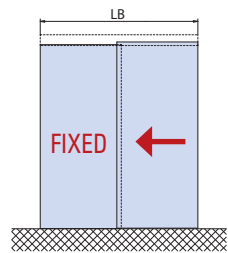

$$LB = LP$$

$$LM = (LP + 50) / 2$$

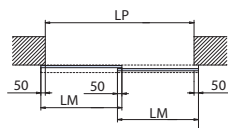

$$LB = LP + 100$$

$$LM = (LP + 150) / 2$$

### V-5103 | V-5153 SET 2

- Set per 2 ante scorrevoli e vetri fissi, fissaggio a parete/soffitto
- Sliding doors set with fixed panels, wall/ceiling installation
- Schiebetürset für 2 flg mit Seitenteil, Wand-Deckenmontage

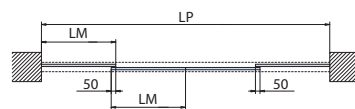
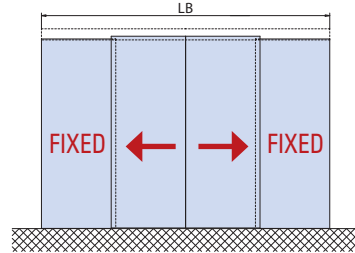

$$LB = LP$$

$$LM = (LP + 100) / 4$$

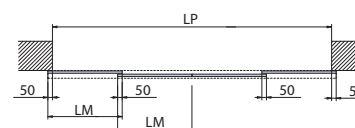

$$LB = LP + 100$$

$$LM = (LP + 200) / 4$$

### LAVORAZIONE VETRO GLASS PREPARATION GLASBEARBEITUNG

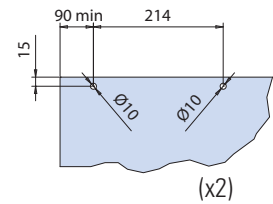

(x2)

- Fori optional per V-5102
- Holes optional for V-5102
- Bohrungen Optional für V-5102

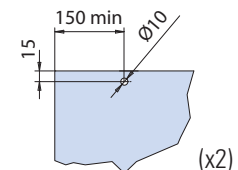

(x2)

- Foro optional per V-5152
- Hole optional for V-5152
- Bohrung Optional für V-5152

xla213 / xla214 / xla215

## COMPONENTI | COMPONENTS | EINZELTEILE



V-5103



V-5102 120 Kg



V-5152 60 Kg



V-5111

Cod.	Fin.   Fin. Oberf.	V-5103 SET 1 FIX	V-5103 SET 1-MIS	V-5103 SET 2 FIX	V-5103 SET 2-MIS	V-5153 SET 1 FIX	V-5153 SET 1-MIS	V-5153 SET 2 FIX	V-5153 SET 2-MIS
V-5103	L=2000 L=2500 L=3000 L=4000 L=6000	AN / IXE	1	-	1	-	1	-	1
V-5103-MIS	L=1500 → 6000	AN / IXE	-	1	-	1	-	-	1
V-5102	-	-	1	1	2	2	-	-	-
V-5152	-	-	-	-	-	1	1	2	2
V-012	AN / NS	1	1	2	2	1	1	2	2
V-5111 (OPTIONAL)	AN / IXE	(1)	(1)	(1)	(1)	(1)	(1)	(1)	(1)

## EVOLUTION - V-5100 | V-5103 | V-5150 | V-5153 | V-5140

### COMPONENTI | COMPONENTS | EINZELTEILE

#### V-5100

- Binario Evolution
- Track profile Evolution
- Laufschiene Evolution

AN-IXE

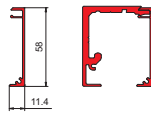

xfb-067

#### V-5103

- Binario Evolution per anta scorrevole con vetro fisso laterale
- Track profile Evolution for sliding panel and fixed side panel
- Laufschiene Evolution für Schiebetür und Seitenteil

AN-IXE

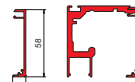
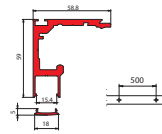

xfb-067

#### V-5102

- Set carrelli con pinze e stopper per 1 anta scorrevole
- Set roller carriers and stoppers for 1 panel
- Set Klemm-Laufwagen und stopper für 1 Flügel

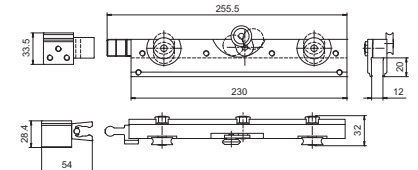

xfb-067

#### V-5152

- Set carrelli con pinze e stopper per 1 anta scorrevole
- Set roller carriers and stoppers for 1 panel
- Set Klemm-Laufwagen und stopper für 1 Flügel

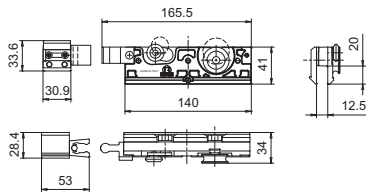

xfb-067

#### V-5006

- Punto per fissaggio a vetro fisso della guida V-5100.
- Point fitting to fix track profile V-5100 on glass.
- Punktbefestigung für Glasmontage Schiene V-5100.

AN-IXE

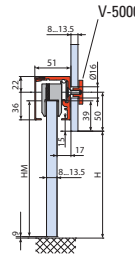
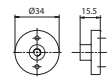

xla-211

#### V-5101

- Paio tappi finali in plastica per guida a scorrimento V-5100.
- Pair plastic endcaps for track profile V-5100.
- Paar Endkappenn aus Kunststoff für Laufschiene V-5100.

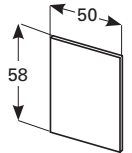
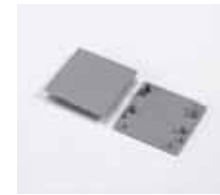

xla-209

#### V-5111

- Paio tappi finali in alluminio per guida a scorrimento V-5103.
- Pair aluminium endcaps for track profile V-5103.
- Paar Endkappenn aus Aluminium für Laufschiene V-5103.

AN-IXE

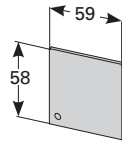
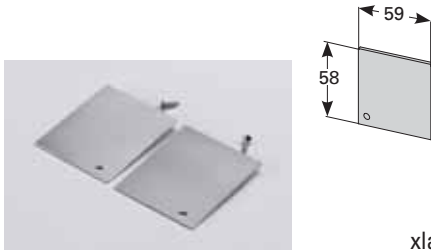

xla-209

#### V-5112

- N°1 Staffa evolution autoportante reversibile DX-SX per fissaggio laterale binario V-5103/muro.
- 1 pcs bracket for side fixing evolution profile v-5103.
- 1 Stück Winkelprofil für seitliche Wandbefestigung Evolution Laufschiene V-5103.

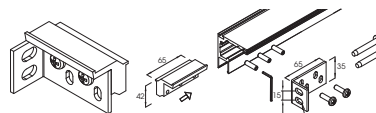

- Esempio applicazione
- Installation example
- Einbaubeispiel

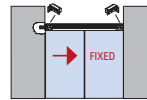

xme146

#### V-5107

- Set per spessori vetro 12 - 12,7 - 13,5 (per 2 pinze V-5102).
- Set spacers for glass thickness 12 - 12,7 - 13,5 (for 2 clamps V-5102).
- Set distanzscheiben für Glasdicke 12 - 12,7 - 13,5 (für 2 Klemm-Laufwagen V-5102).

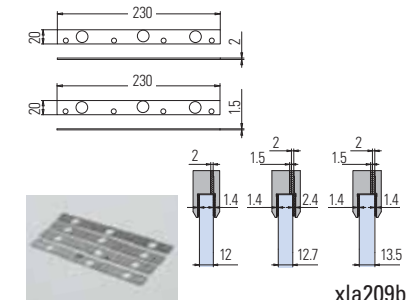

xla209b

#### V-5142

- Set accessori per 1 anta scorrevole in legno composto da: 2 carrelli con morsetti per porte in legno e 2 stopper.
- Accessory set for 1 sliding wooden door panel consisting of 2 trolley hangers with clamp carriage for wooden door and 2 stoppers
- Zubehör komplett für 1 Holz Schiebetür bestehend aus: N° 2 Klemm-Laufwagen für Holztür und 2 Stoppers.

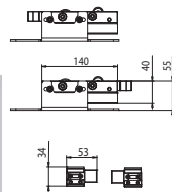

xla355

#### V-5307

- Set staffe per fissaggio carrelli con pannello in legno.
- Pair suspension plates hanger with wooden doors.
- Paar Winkel mit Holztüren.

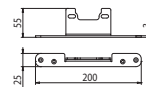

xla-355

#### V-5110

- Extra montaggio kit Evolution per chiusura simultanea 2 ante. Larghezza minima anta 600 mm (senza fori di sicurezza vetro).
- Extra cost for kit 2 panels synchronously opening. Min. door width 600 mm (without security holes in glass).
- Aufpreis Set für 2 Synchron öffnende Schiebetaile. Min. Flügelbreite 600 mm (ohne Sicherheitsbohrungen in Glas)

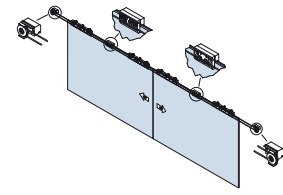

xme-094